

## 1. INSPECTION AND PREPARATION OF THE SUBFLOOR

The product may be laid on the following subfloors:

- New or old subfloors such as:
  - Separate cement screeds or concrete slabs
  - Concrete paving
  - Intermediate and upper concrete slabs and floors
  - Cement or calcium sulphate-based liquid screeds
  - Asphalt concrete
  - Asphalt screed
- The following are also concerned:
  - Glued old sports floor coverings (PVC, rubber, resin, etc.)
  - Painted concrete
  - Old glued parquet flooring (in this case, do not use plastic film)

Local standards have to be applied and the following requirements must be satisfied:

- Surface evenness less than 5 mm when measured with a 2 m straightedge and 1 mm when measured with a 20 cm straightedge.
- Subfloor humidity less than 3 % at a depth of 2 cm using the carbide bomb meter test.
- The concrete must offer an average compressive strength of > 24.13 MPa after 28 days.

In the event of a nonconforming subfloor, it must be prepared in accordance with the product manufacturer's instructions.

## 2. PRODUCTS

**NOTE :** before you start work, check with our technical services whether this data sheet has been amended by a more recent version. Examine the materials prior to installation to ensure that there are no visual defects. If the flooring has already been installed, the cost of any remedial work will not be covered.

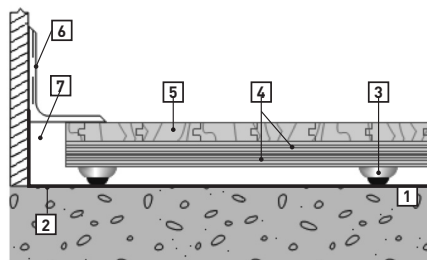

### DESCRIPTION

1. Concrete slab
2. Polyethylene (0.15 mm)
3. Neoshok pads
4. Timber panels 1,250 x 2,500 mm (2 x 12 mm-thick layers)
5. Flooring
6. Vented cove base 76 mm x 102 mm
7. Expansion space (38 mm)

## 3. SUBFLOOR CONSTRUCTION: FLOORING AND TOOLS

MATERIALS SUPPLIED WITH THE ORDER BY GERFLOR	MATERIALS AVAILABLE ON ORDER FROM GERFLOR	MATERIALS AND TOOLS SUPPLIED BY THE INSTALLER
FOR THE SUBFLOOR CONSTRUCTION		
		Staples (25 mm) for the panels
Neoshok pad / 4 x 5 x 1.9 cm / Quantity: 10.76/m <sup>2</sup>		Staples (10 to 12 mm) for the pads
Maritime pine plywood panels: 1,250 x 2,500 mm	Vented cove base (1.22 linear metres) / 16 units	Circular saw / jigsaw
Polyethylene 0.15 mm / 1 box (185.7 m <sup>2</sup> )		Electric screwdriver
Template / 1,250 x 2,500 mm		staple gun
		Hammer
		Wood adhesive sealant
FOR THE FLOORING		
Flooring bundles = 1.6 m <sup>2</sup> / length from 0.23 m to 2.40 m Width: 57 mm	For Neoshok: Staples 50 mm / 5,000 units / 1 box (60 m <sup>2</sup> )	Staple gun, such as Bostitch MIIIIFS, for fixing Connor flooring
		Shims
	Spline	Hammer
		Adhesive sealant

## 4. CONDITIONS AND PREPARATION OF THE GYMNASIUM

### ■ 4.1 - STORAGE

The materials required to install the NEOSHOK panels must be stored on site, in a dry area of the gymnasium that is protected from variations in temperature.

### ■ 4.2 - ACCLIMATISATION PERIOD

**IMPORTANT :** three days prior to installation, the ambient temperature in the room must be between 15 and 30°C. Relative humidity must be between 30 and 60 %. Once these conditions are met, all protective coverings and packaging can be removed to allow the materials to acclimatise. After unpacking, the materials must be left to rest for three days before installing.

While installing the subfloor construction, maintain the same conditions (i.e. ambient temperature from 15 to 30°C and relative humidity between 30 and 60 %). If there is any moisture in the room (such as a new build), you are advised to ventilate the room for four to six weeks before installing the subfloor construction. Ensure that the room is ventilated throughout installation.

## 5. LAYING THE POLYETHYLENE VAPOUR BARRIERE

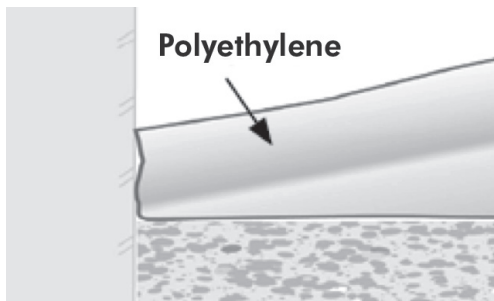

A polyethylene vapour barrier with a thickness of at least 150 microns must be laid across the entire subfloor.

**Coving:** the vapour barrier must be turned up at the edges of the room by at least 5 cm to reach the finished floor level. After woodfloor's installation, the vapour barrier must not be viewable. It may be cut if necessary.

**Use of two vapour barriers:** the barriers must overlap 20 cm minimum. Overlaps are bonded using single-sided moisture-resistant adhesive tape and by width of 5 cm.

## 6. INSTALLING THE RED PADS

Staple the Neoshok pads to the underside of the panels forming the first plywood layer using the template (32 pads per full panel).

Use at least two staples (10 to 12 mm) per pad.

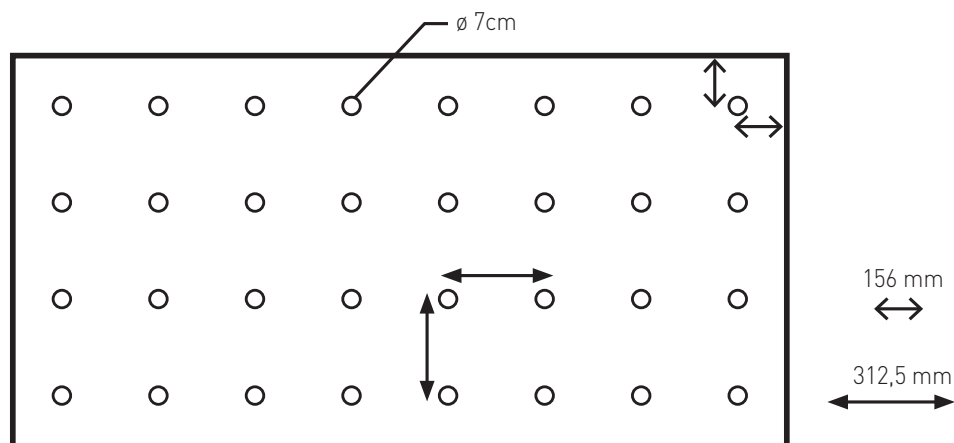

## 7. REINFORCEMENT BLOCKS

19 mm reinforcement blocks must be installed instead of resilient pads in areas subject to permanent or frequent high static loads (retractable seating systems in the stacked position, in front of access doors, storage areas, etc.).

15 mm partial reinforcement blocks must be added between resilient pads in areas subject to occasional high static loads (retractable seating systems in the open position, non-permanent portable equipment, etc.).

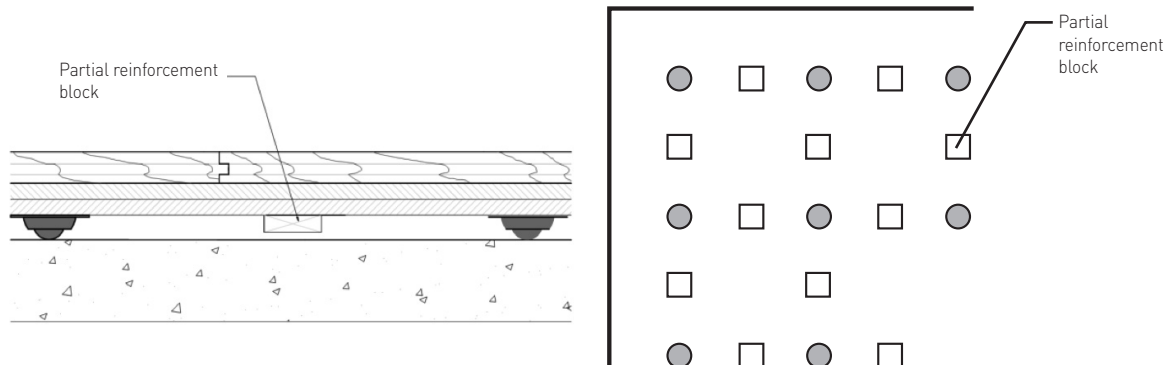

## 8. PANEL LAYING DIRECTION

When laying Connor flooring on top of this subfloor construction, the first panel of the subfloor must be perpendicular to the flooring with a space of 6 mm between each panel and staggering joints at 1.20 m.

Provide a 38 mm expansion void at the perimeter and at all vertical obstructions (posts, stands, etc.).

## 9. INSTALLING THE FIRST LAYER OF PANELS

Install the panels by starting in a corner of the gymnasium and work from right to left. Cut full panels in half to form half panels for installing the rows with staggered joints.

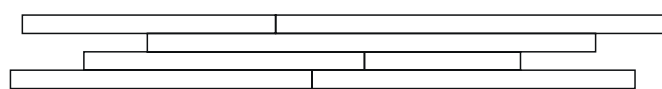

FLOORING LAYING DIRECTION

- ① Full panels
- ② 6 mm spacing
- ③ Half panels

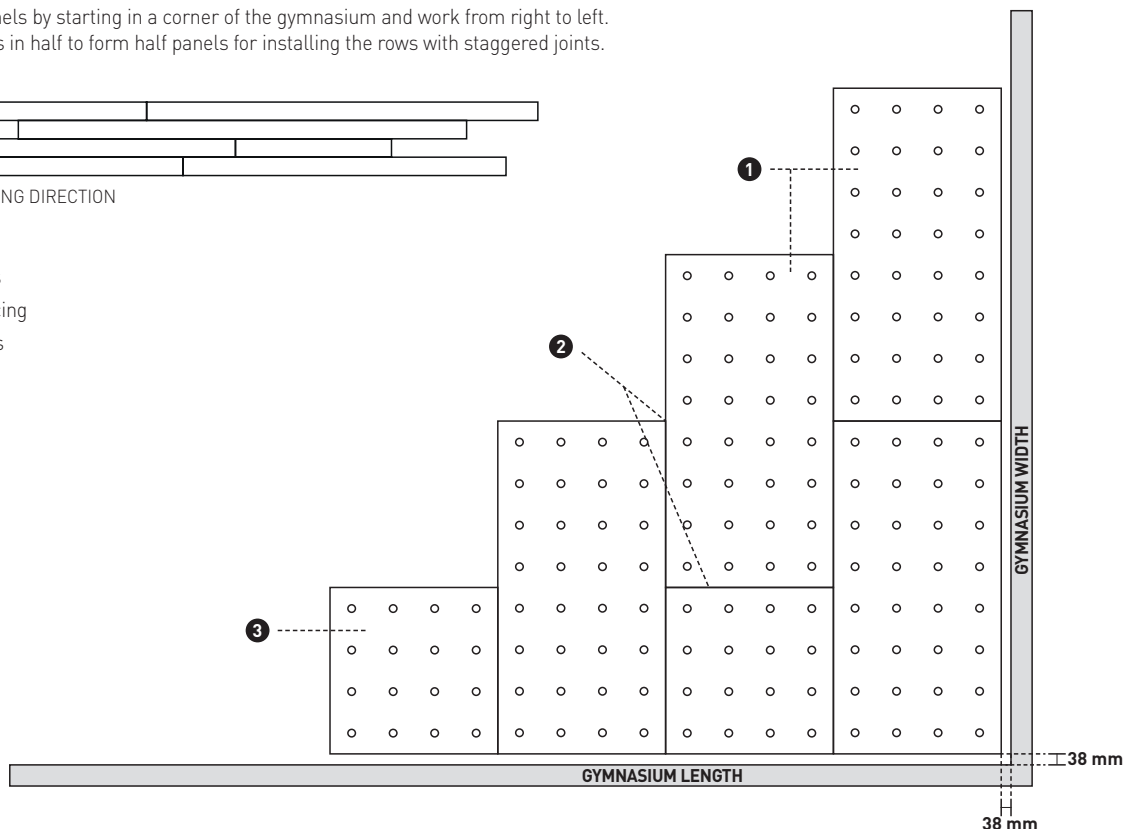

## 10. INSTALLING THE SECOND LAYER OF PANELS

### 10.1. INSTALLING THE FIRST ROW

First of all, cut a full panel according to this method to obtain perfectly square angles of 90° and 45°.

Lay the panels at a 45° angle over the first layer.

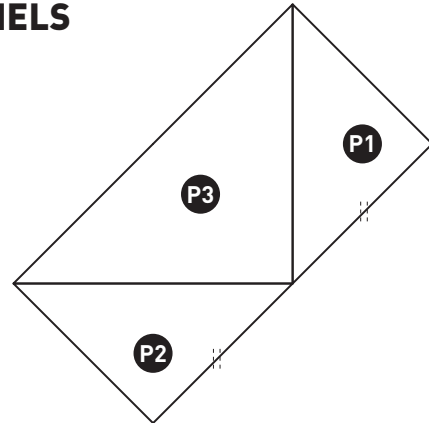

Leave a space of 6 mm and stagger the joints at 1.20 m.  
Provide a 38 mm expansion void at the perimeter and at all vertical obstructions (posts, stands, etc.).  
Install the full panel as shown in the diagram.  
Install the small panels as shown in the diagram, leaving a space of 6 mm between the panels.  
Staple the panels to the first layer using the same template as the one used for the Neoshok pads.  
Use 25 mm staples.

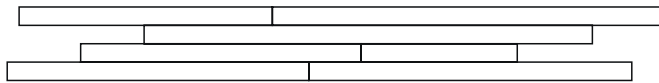
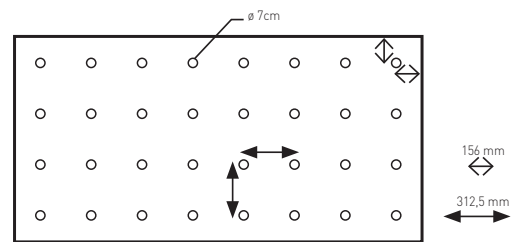

FLOORING LAYING DIRECTION

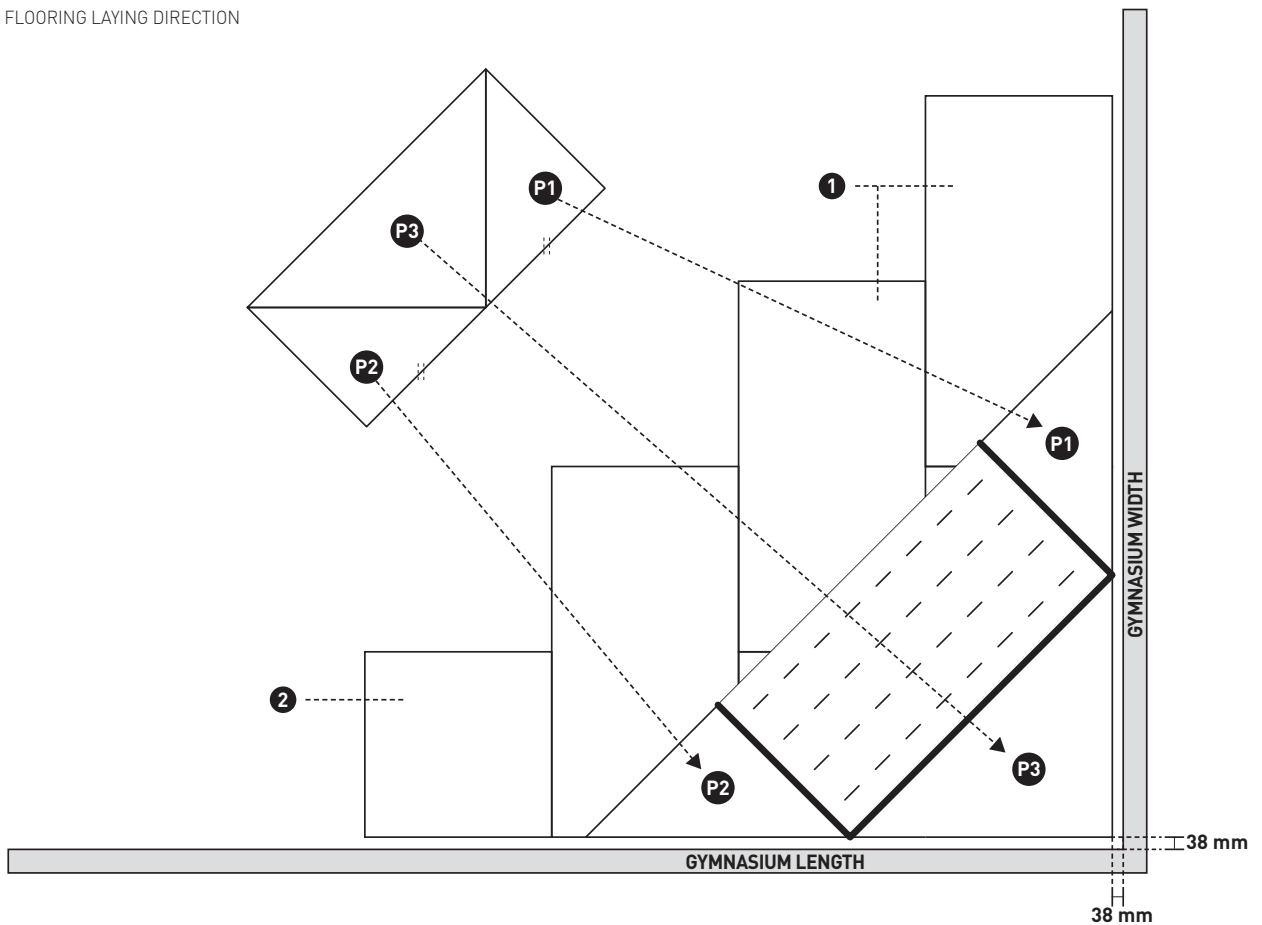

**10.2. INSTALLING THE FOLLOWING PANELS**

Continue placing full panels and end triangles with a space of 6 mm along all sides.  
Staple the panels to the first layer using the same template as the one used for the Neoshok pads.  
Use 25 mm staples.

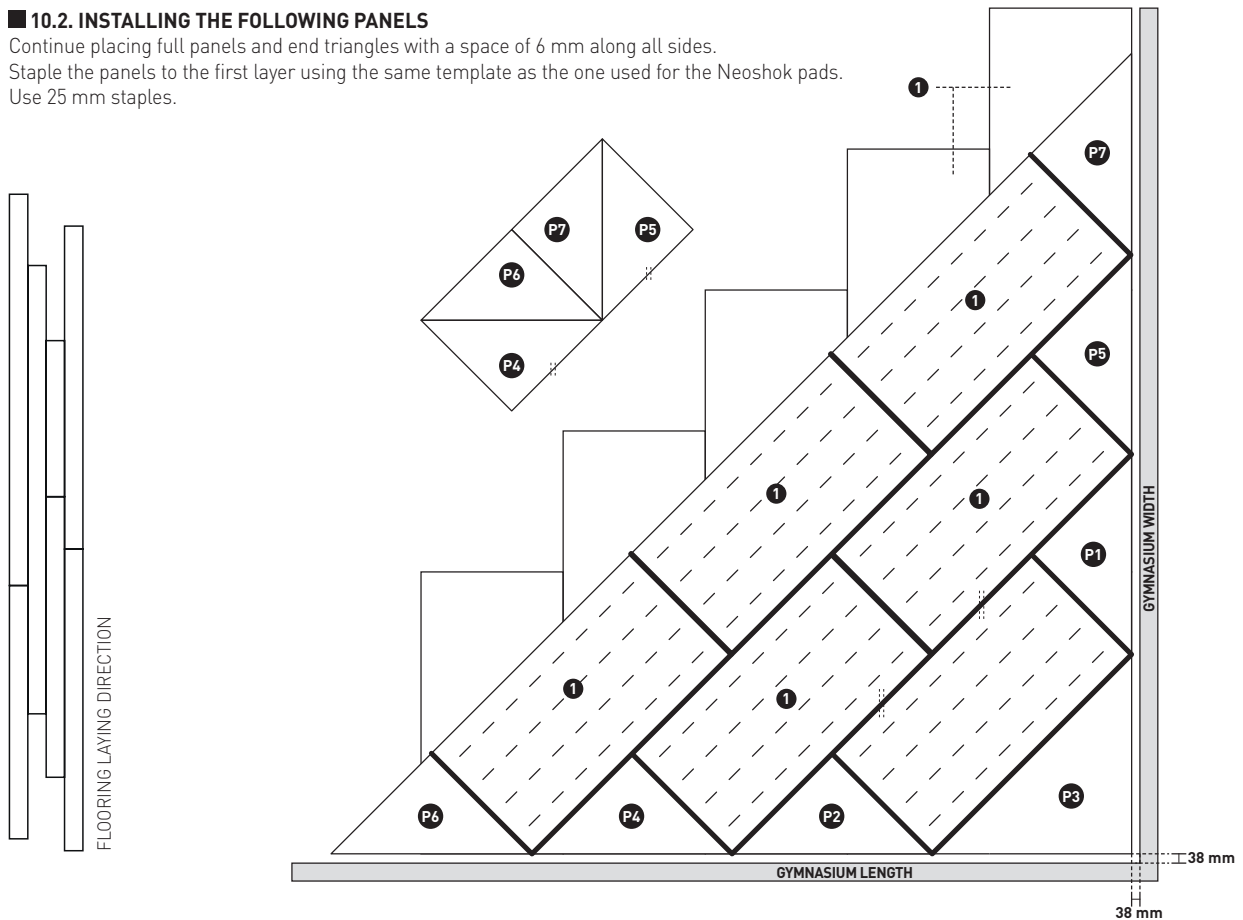

**11. INSTALLING THE FLOORING**

**11.1 - DEFINE THE EXPANSION GAPS**

- After maple strips acclimatization period (§4.2), **realize moisture measurements** in the maple strips with a moisture indicator. Realize measurements using different maple strips bundles and in different localization in the bundles. The average value is your «maple moisture content during installation» (IMC).
- According to your **local area knowledge about maple moisture** value in time:
  - If you know the highest maple value you can reach, consider it as «maple moisture level during its life» (LMC)
  - If you know the facility will have a controlled environment including relative humidity between 35% and 50%, consider 9% as your «maple moisture level during its life» (LMC)
  - If you don't know the highest maple value you can reach, consider 13% as your «maple moisture level during its life» (LMC).
- Calculate the difference** between your value of «maple moisture level during its life» (LMC) and your value of «maple moisture content during installation» (IMC). We will call this result the "maple moisture content to cover" (MCC) -> **(MCC) = (LMC) - (IMC)**
- Define the expansion gaps.** According your "maple moisture content to cover" (MCC) value, you can define the expansion gaps to manage on the playground during the installation.

	EXPANSION GAP BETWEEN EACH STRIP	EXPANSION GAP EVERY 4 STRIPS	EXPANSION GAP EVERY 6 STRIPS	EXPANSION GAP EVERY 8 STRIPS
0% < MCC < 1%	0,07 mm	0,28 mm	0,42 mm	0,56 mm
1% < MCC < 2%	0,15 mm	0,60 mm	0,90 mm	1,20 mm
2% < MCC < 3%	0,20 mm	0,80 mm	1,20 mm	1,60 mm
3% < MCC	0,25 mm	1,00 mm	1,50 mm	2,00 mm

Values to consider for maple strip of 57 mm width.

For example, if MCC = 1,5%, you need to insure a gap of 0,60 mm every 4 strips or a gap of 0,90 mm every 6 strips using shims.

For aspect reasons:

- We recommend to realize expansion gaps under 1,50 mm,
- We recommend to provide smaller expansion gaps more frequently rather than wider expansion gaps in lower quantity.

■ 11.2 - LAYING THE FLOORING

11.2.1 - Installation along the longitudinal axis

Install the flooring strips by starting in the middle of the gymnasium.

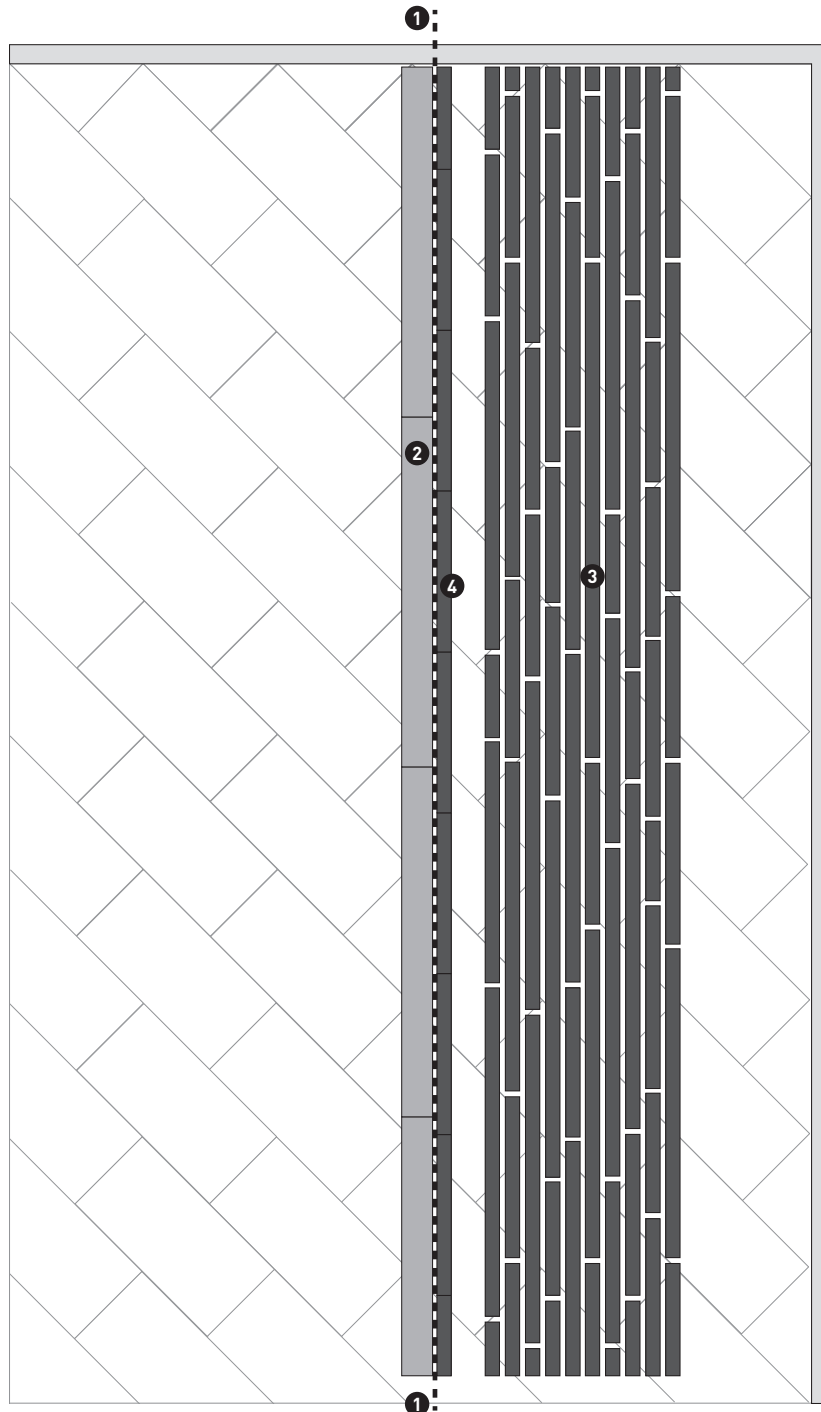

- 1 Mark out the longitudinal axis along the subfloor construction.
- 2 Provisionally fix plywood sheets along the longitudinal axis.
- 3 Present and sort the strips so that they are ready to be stapled according to the following rule:

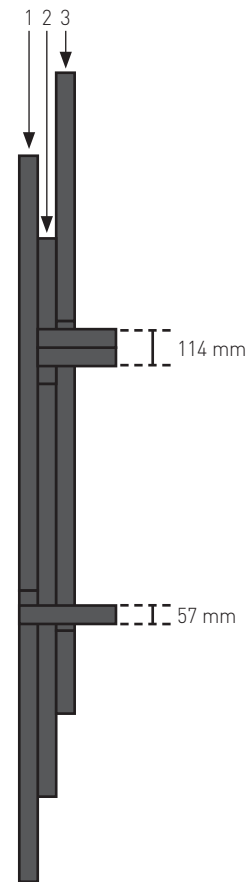

- The offset in joints between two consecutive rows must be greater than 114 mm (width of two strips).
- The offset in joints between three consecutive rows must be greater than 57 mm (width of one strip).

- 4 Staple a row of strips along the axis using the plywood sheets as a guide.

Add shims according to value you define using §11.1

Don't remove a line of shims before the realisation of a new line of shims

**TIPS**

To have shims easy removal:

- Be sure to respect the pressure recommendation of your staple gun.
- Remove your expansion gaps blocks at least at the end of the day.



11.2.2- Installing the second half of the gymnasium

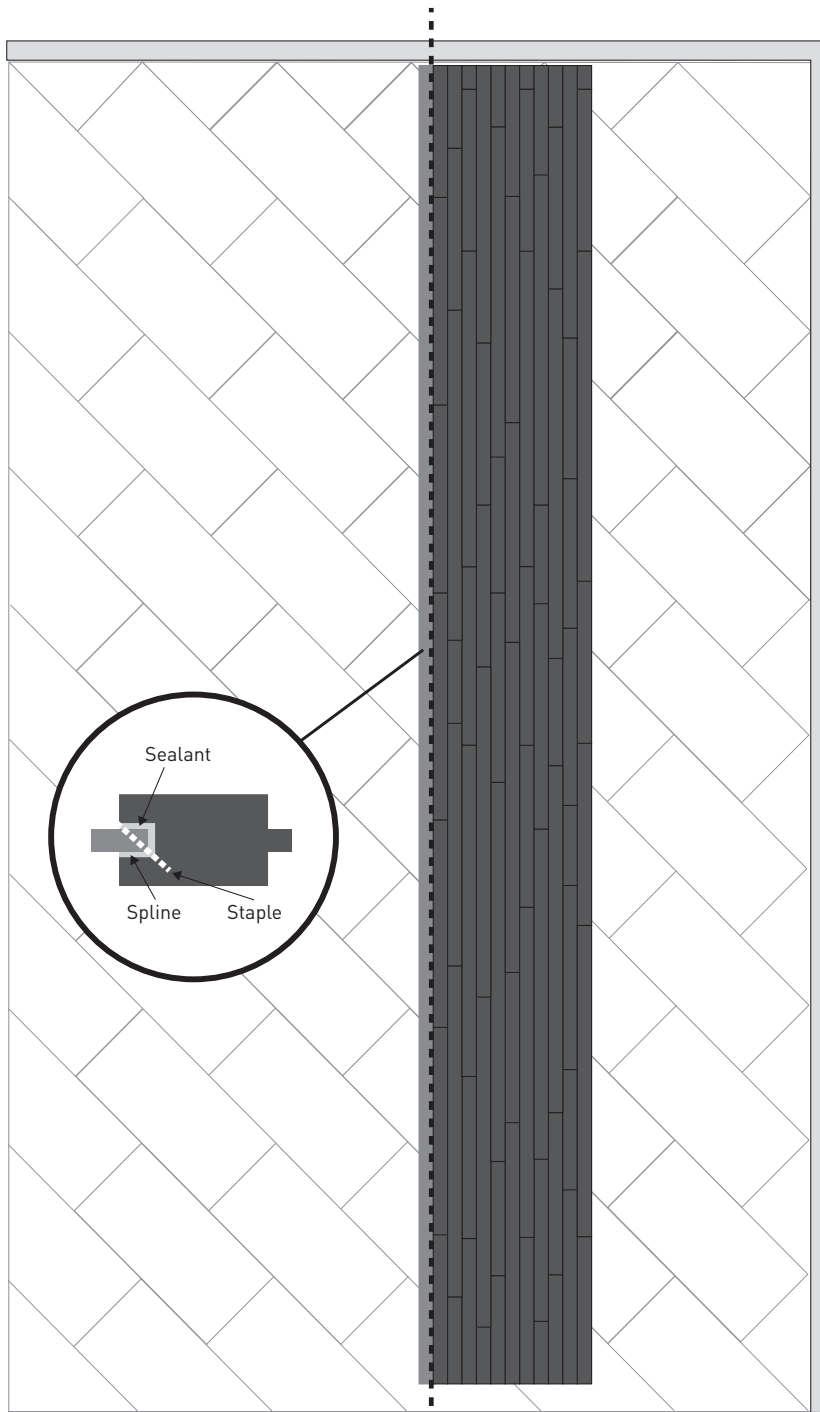

Fixing the spline



Applying the spline in the groove of the strips along the longitudinal axis:

- Remove the plywood sheets.
- Apply adhesive sealant to the bottom of the groove.
- Gently tap the spline into place using a hammer.
- Staple the spline to the flooring.

### ■ 11.3 - FIXING THE STRIPS

#### 11.3.1- Installation

Strips must be stapled with a staple gun, such as Bostitch MIIIIFS ([www.bostitch.fr](http://www.bostitch.fr)).

#### Recommendations for Neoshok:

Staple every 30 cm maximum. Do not staple less than 3 cm from the end of a strip.

Use at least two staples per strip (for strips longer than 40 cm).

#### TIPS

To ensure the proper functioning of the staple gun:

- Be careful to respect the pressure recommendation
- Use and add lubricant preconsised by the staple gun provider every day of working.

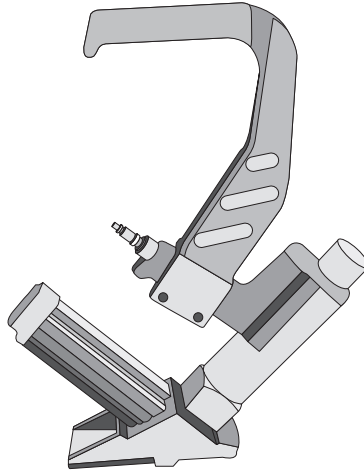

#### 11.3.2 - Finishes

##### 11.3.2.1. Installing edging strips

The last rows of strips that cannot be stapled must be glued in the tongues and grooves.

Use a pull bar to fit the last row, which will have been previously cut (using a marking gauge).

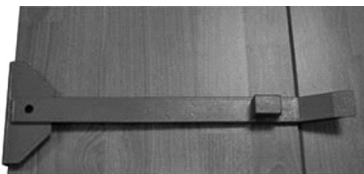

##### 11.3.2.2. Peripheral expansion

- If installing on panels, leave a 38 mm expansion void at the perimeter.

## 12. SANDING, SEALING AND PAINTING CONNOR FLOORING

GERFLOR validated the sanding and sealing associated with BLANCHON, BONA and POLOPLAZ suppliers.

Depending on the products used, refer to the corresponding Installation guideline.

